

# Operating Instructions

HOB

GB

English, 1

FR

Français, 14

ES

Espanol, 27

PT

Português, 41

AR

عربي

**NRO 642 D Z**  
**NRO 841 O X**

## Contents

GB

### Installation, 2-4

Positioning  
Electrical connection

### Description of the appliance, 5-6

Control panel  
Extendable cooking zones

### Start-up and use, 7-10

Switching on the hob  
Switching on the cooking zones  
Switching off the cooking zones  
Power function  
Heating elements  
Programming the cooking duration  
Timer  
Control panel lock  
Switching off the hob  
"Demo" mode  
Practical advice on using the appliance  
Safety devices  
Practical cooking advice

### Precautions and tips, 11

General safety  
Disposal

### Care and maintenance, 12

Switching the appliance off  
Cleaning the appliance  
Disassembling the hob

### Technical description of the models, 13



**ARISTON**

# Installation

GB

! Before operating your new appliance please read this instruction booklet carefully. It contains important information concerning the safe operation, installation and maintenance of the appliance.  
! Please keep these operating instructions for future reference. Pass them on to any new owners of the appliance.

## Positioning

! Keep all packaging material out of the reach of children. It may present a choking or suffocation hazard (see *Precautions and tips*).  
! The appliance must be installed by a qualified professional in accordance with the instructions provided. Incorrect installation may cause harm to people and animals or may damage property.

### Built-in appliance

Use a suitable cabinet to ensure that the appliance functions properly.

- The supporting surface must be heat-resistant up to a temperature of approximately 100°C.
- If the appliance is to be installed above an oven, the oven must be equipped with a forced ventilation cooling system.
- Avoid installing the hob above a dishwasher: if this cannot be avoided, place a waterproof separation device between the two appliances.
- Depending on the hob you want to install, the cabinet must have the following dimensions (see figure):

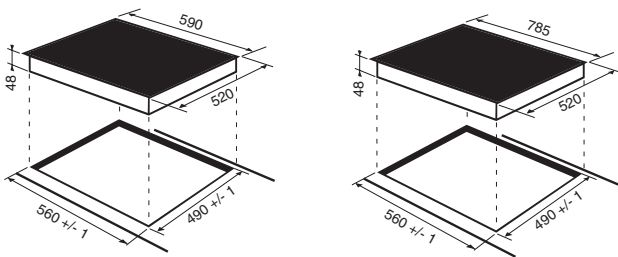

### Ventilation

To allow adequate ventilation and to avoid overheating of the surrounding surfaces the hob should be positioned as follows:

- At a minimum distance of 40 mm from the back panel.
- So that a minimum distance of 20 mm is maintained between the installation cavity and the cabinet underneath.
- Kitchen cabinets adjacent to the appliance and taller than the top of the hob must be at least 600 mm from the edge of the hob.

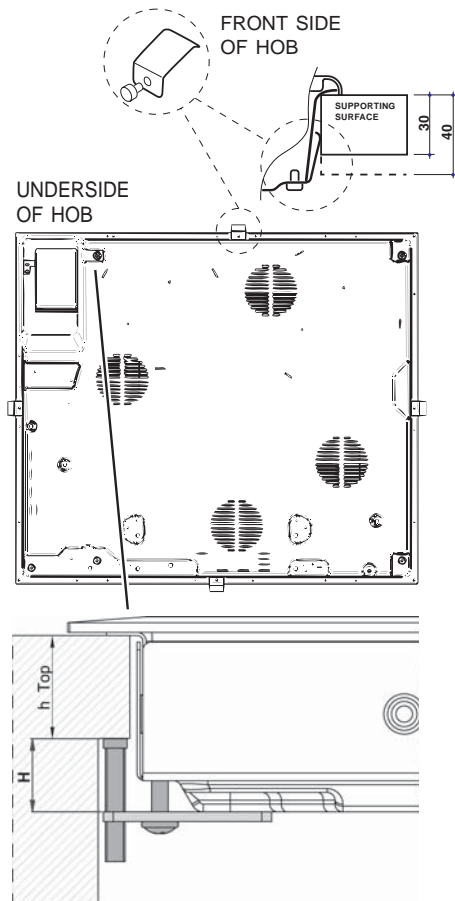
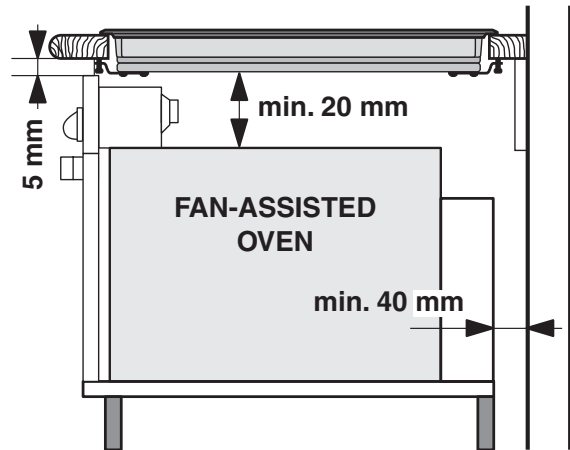
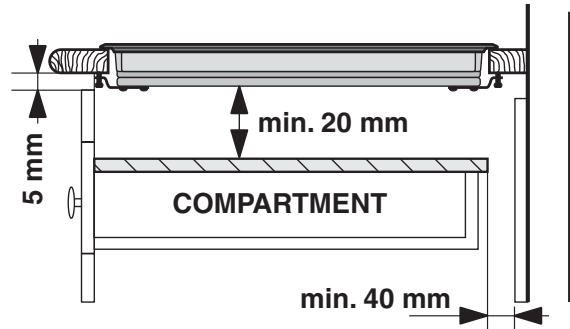

## Fixing

The appliance must be installed on a perfectly level supporting surface.

Any deformities caused by improper fixing could affect the features and operation of the hob.

The thickness of the supporting surface should be taken into account when choosing the length of the screws for the fixing hooks:

- 30 mm thick: 17.5 mm screws
- 40 mm thick: 7.5 mm screws

Fix the hob as follows:

1. Use short flat-bottomed screws to fix the 4 alignment springs in the holes provided at the central point of each side of the hob.
2. Place the hob in the cavity, make sure it is in a central position and push down on the whole perimeter until the hob is stuck to the supporting surface.
3. For hobs with raised sides: After inserting the hob into its cavity, insert the 4 fixing hooks (each has its own pin) into the lower edges of the hob, using the long pointed screws to fix them in place, until the glass is stuck to the supporting surface.

! The screws for the alignment springs must remain accessible.

! In order to adhere to safety standards, the appliance must not come into contact with electrical parts once it has been installed.

! All parts which ensure the safe operation of the appliance must not be removable without the aid of a tool.

## Electrical connection

! The electrical connection for the hob and for any built-in oven must be carried out separately, both for safety purposes and to make extracting the oven easier.

### Terminal board

UNDERSIDE OF HOB

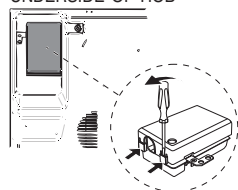

On the lower part of the appliance there is a connection box for the different types of electricity supply (the picture is only an indication and is not an exact representation of the purchased model).

## Single-phase connection

The hob is equipped with a pre-connected electricity supply cable, which is designed for single-phase connection. Connect the wires in accordance with the instructions given in the following table and diagrams:

Voltage and mains frequency	Electrical cable	Wire connection
230-240V 1+N ~ 220-240V 1+N ~ 50/60 Hz		⏏: yellow/green; N: the two blue wires together L: brown and black together

## Other types of connection

If the mains supply corresponds with one of the following:

Voltage and mains frequency

- 400V - 2+N ~ 50/60 Hz
- 220-240V 3 ~ 50/60 Hz
- 230-240V 3 ~ 50/60 Hz
- 400V - 2+2N ~ 50/60 Hz

Separate the wires and connect them in accordance with the instructions given in the following table and diagrams:

Voltage and mains frequency	Electrical cable	Wire connection
400V - 2+N ~ 50/60 Hz		⏏: yellow/green; N: the two blue wires together L1: black L2: brown
230-240V 3 ~ 220-240V 3 ~ 50/60Hz		⏏: yellow/green; N1: blue N2: blue L1: black L2: brown

If the mains supply corresponds with one of the following:

Voltage and mains frequency

- 400V 3 - N ~ 50/60 Hz

proceed as follows:

! The cable provided is not suitable for the following types of installation.

1. Use a suitable supply cable, H05RR-F or higher, with the right dimensions (cable cross section: 25 mm).
2. To open the terminal board, use a screwdriver as a lever under the side tabs of the cover (*see Terminal board picture*).
3. Loosen the cable clamp screw and the terminal board screws in accordance with the type of

connection required and position the connection supports as shown in the following table and diagrams.

4. Position the wires in accordance with the information given in the following table and diagrams and connect the appliance by tightening all the screws for the springs as much as possible.

Voltage and mains frequency	Electrical connections	Terminal board
400V 3-N ~ 50/60 Hz		Three-phase 400

5. Secure the power supply cable by fastening the cable clamp screw, then put the cover back on.

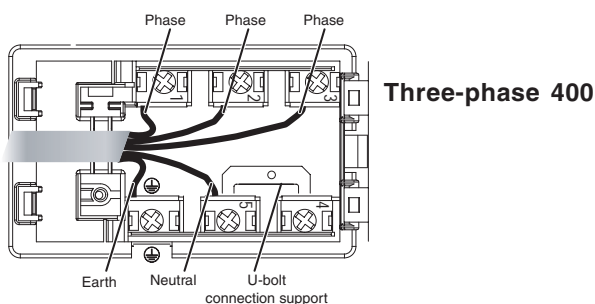

## Connecting the electricity supply cable to the mains

If the appliance is being connected directly to the electricity mains an omnipolar switch must be installed with a minimum opening of 3 mm between contacts.

! The installer must ensure that the correct electrical connection has been made and that it is fully compliant with safety regulations.

Before connecting the appliance to the power supply, make sure that:

- The appliance is earthed and the plug is compliant with the law.
- The socket can withstand the maximum power of the appliance, which is indicated on the data plate located on the appliance itself.
- The voltage falls within the range of values indicated on the data plate.
- The socket is compatible with the plug of the appliance. If the socket is incompatible with the plug, ask an authorised technician to replace it. Do not use extension cords or multiple sockets.

! Once the appliance has been installed, the power supply cable and the electrical socket must be easily accessible.

! The cable must not be bent or compressed.

! The cable must be checked regularly and replaced by authorised technicians only.

**! The manufacturer declines any liability should these safety measures not be observed.**

# Description of the appliance

## Control panel

The control panel described in this manual is only a representative example: it may not exactly match the panel on your appliance.

GB

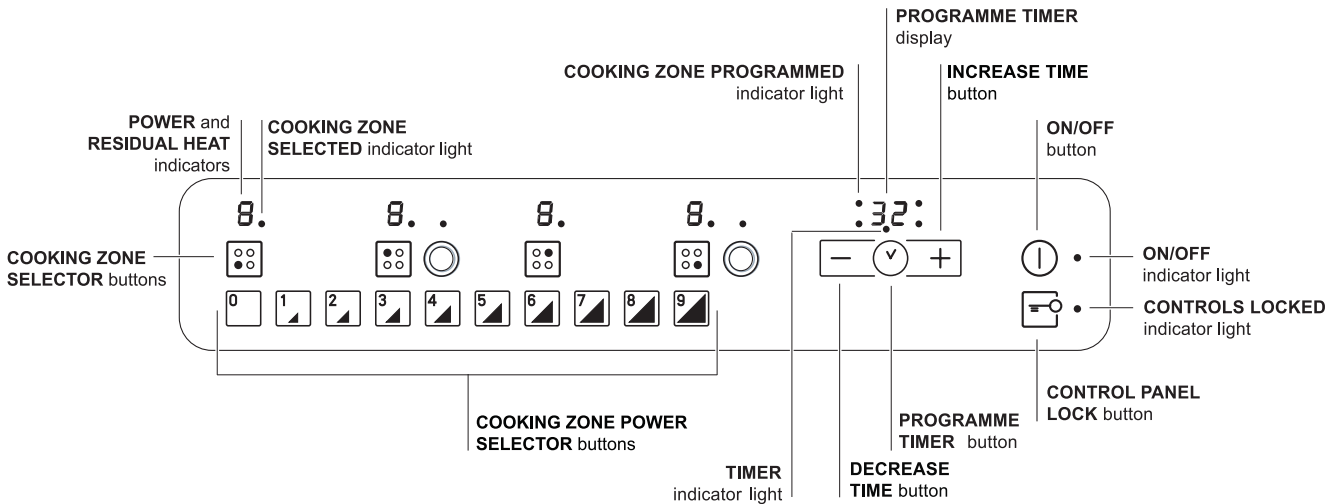

- **INCREASE TIME** button increases the time value set on the timer (*see Start-up and use*).
- **DECREASE TIME** button decreases the time value set on the timer (*see Start-up and use*).
- **COOKING ZONE SELECTOR** button shows a particular cooking zone has been selected and therefore various adjustments are possible.
- **COOKING ZONE SELECTOR** button is used to select the desired cooking zone.
- **POWER** indicator provides a visual display for the current heat level.
- **ON/OFF** button switches the appliance on and off.
- **ON/OFF** indicator light shows whether the appliance is on or off.
- **PROGRAMME TIMER** button controls the cooking programme times (*see Start-up and use*).
- **PROGRAMME TIMER** display shows which programme has been selected (*see Start-up and use*).
- **COOKING ZONE PROGRAMMED** indicator lights show which cooking zones are being used during a cooking programme (*see Start-up and use*).
- **CONTROL PANEL LOCK** button prevents accidental changes to the hob settings (*see Start-up and use*).
- **CONTROL PANEL LOCK** indicator light shows the control panel has been locked (*see Start-up and use*).
- **COOKING ZONE POWER SELECTOR** buttons switch on the hotplate and control the power (*see Start-up and use*).
- **TIMER** indicator light shows that the timer has been activated

## Extendable cooking zones

Certain models are fitted with extendable cooking zones. These may be circular or oval and may vary in their extensibility (they may be double or triple hotplates). A list of controls is given below (these controls are only present in models with the extendable cooking zone option).

### Circular extendable hotplate

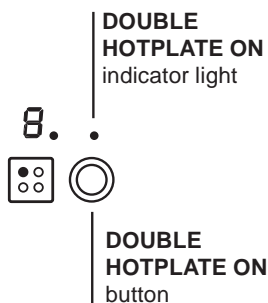

- **DOUBLE HOTPLATE ON** button switches on the double hotplate (*see Start-up and use*).
- **DOUBLE HOTPLATE ON** indicator light shows the double hotplate has been switched on.

### Oval extendable hotplate

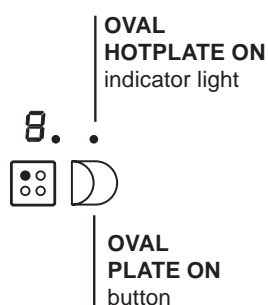

- **OVAL HOTPLATE ON** button switches on the oval hotplate (*see Start-up and use*).
- **OVAL HOTPLATE ON** indicator light shows the oval hotplate has been switched on.

! The glue applied on the gaskets leaves traces of grease on the glass. Before using the appliance, we recommend you remove these with a special non-abrasive cleaning product. During the first few hours of use there may be a smell of rubber which will disappear very quickly.

! A few seconds after the hob is connected to the electricity supply, a buzzer will sound. The hob may now be switched on.

! If the **-** or **+** button is pressed for an extended period of time, the display scrolls quickly through the power levels and timer minutes.

## Switching on the hob

To switch the hob on, press and hold the  button for approximately one second.

## Switching on the cooking zones

Each cooking zone is controlled using a selector button  and a power adjustment device consisting of power level selector buttons between the values of 0 and 9.



- To begin operating a cooking zone, press the corresponding control button and set the desired power level using the power level selector buttons between 0 and 9.

## Switching off the cooking zones

To switch off a cooking zone, select it using the corresponding selector button  and:

- Press power level selector button 0: this immediately returns the power setting to 0 and the cooking zone switches off.

## Power function

The power function for the cooking zones may be used to shorten heating-up times. Activate and set the power level for the desired cooking zone  as described in the previous paragraph. Press and hold the selector button corresponding to the desired cooking zone  for at least 2 seconds. The display, the power level indicator, will alternately show the letter "P" and the power level set previously until the desired power level has been

reached. Once this level has been reached, the display will revert to showing the set power level. To deactivate this function, press and hold – for at least 2 seconds - the selector button corresponding to the cooking zone on which the  function has been activated; alternatively, select a different power level between 0 and 9 using the power level selector buttons.

## Heating elements

Two types of heating element may be installed, depending on the appliance model: halogen and radiant elements.



Halogen elements emit heat via radiation from the halogen lamps they contain.

They have similar properties to gas burners: they are easy to control and reach set temperatures quickly, allowing you to see the power level instantly.

Radiant elements consist of a series of coils which allow heat to be distributed evenly at the base of the cookware, so that all slow-flame cooking may be performed successfully, for example stews, sauces or reheated dishes.

## Programming the cooking duration

! All the cooking zones may be programmed simultaneously, for a duration between 1 and 99 minutes.

1. Select the cooking zone using the corresponding selector button.
2. Adjust the temperature.
3. Press the  programming button.
4. Set the cooking duration using the **-** and **+** buttons.
5. Confirm by pressing the  button.

The timer begins counting down immediately. A buzzer sounds for approximately 1 minute and the cooking zone switches off when the set programme has finished.

Repeat the above procedure for each hotplate you wish to programme.



## Using multiple programmes and the display

If one or more hotplates are programmed, the display will show the data for the hotplate with the least time remaining, and the light corresponding to the position of the hotplate will flash. The lights corresponding to the other hotplates programmed

will be switched on.

To display the time remaining for the other programmed hotplates, press the  button repeatedly. The times remaining for each hotplate will be shown in a clockwise order, beginning with the front left hotplate.





### Changing the programme

1. Press the  button repeatedly until the duration you wish to change is shown.
2. Use the  buttons to set the new duration.
3. Confirm by pressing the  button.

To cancel a programme, follow the above instructions. At step 2, press the  button: the duration decreases progressively until it reaches 0 and switches off. The programme resets and the display exits programming mode.

### Timer

The hob must be switched on.  
The timer can be used to set a duration up to 99 minutes.

1. Press the  programming button until the timer indicator light is illuminated.
2. Set the desired duration using the  and  buttons.
3. Confirm by pressing the  button.

The timer begins counting down immediately. When the time has elapsed, a buzzer will sound (for one minute).

### Control panel lock

When the hob is switched on, it is possible to lock the oven controls in order to avoid accidental changes being made to the settings (by children, during cleaning, etc.). Press the  button to lock the control panel: the indicator light above the button will switch on.





To use any of the controls (e.g. to stop cooking), you must switch off this function. Press the  button for a few moments, the indicator light will switch off and the lock function will be removed.

### Switching off the hob

Press the  button to switch the appliance off. If the control panel lock has been activated, the controls will continue to be locked even after the hob is switched on again. In order to switch the hob on again, you must first remove the lock function.

### “Demo” mode

It is possible to set the hob to a demonstration mode where all the controls work normally but the heating elements do not switch on. To activate the “demo” mode the hob must be switched on, with all the hotplates switched off.

- Press and hold the  and  buttons simultaneously for 6 seconds. When the 6 seconds have elapsed, the ON/OFF and CONTROLS LOCKED indicator lights will flash for one second. Release the  and  buttons and press the  button;
- The display will show the text DE and MO and the hob will be switched off.
- When the hob is switched on again it will be set to the “demo” mode.

To exit this mode, follow the procedure described above. The display will show the text DE and OF and the hob will be switched off. When it is next switched on, the hob will function normally.

### Practical advice on using the appliance

To obtain the best results from your hob:

- Use pans with a thick, flat base in order to fully utilise the cooking zone.

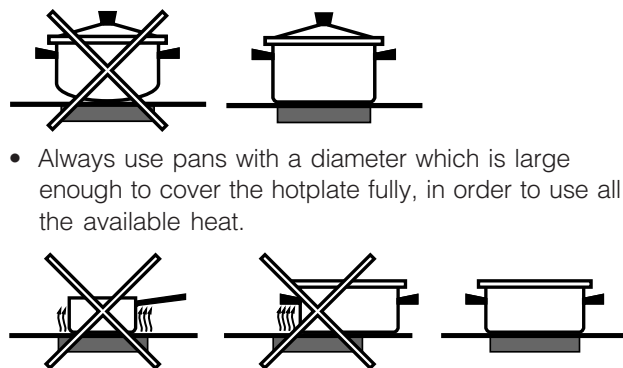

- Always use pans with a diameter which is large enough to cover the hotplate fully, in order to use all the available heat.



- Make sure that the base of the cookware is always clean and dry, in order to fully utilise and extend the life of both the cooking zones and the cookware.
- Avoid using the same cookware which has been used on gas burners: the heat concentration on gas burners may distort the base of the pan, causing it not to adhere correctly.

## Safety devices

### Pan sensor

Each cooking zone is equipped with a pan sensor device. The hotplate only emits heat when a pan with suitable measurements for the cooking zone is placed on it. If the indicator light is flashing, it may indicate:

- An incompatible pan
- A pan whose diameter is too small
- The pan has been removed from the hotplate.

### Residual heat indicators

Each cooking zone is equipped with a residual heat indicator. This indicator signals which cooking zones are still at a high temperature. If the power display

shows **H**, the cooking zone is still hot. It is possible, for example, to keep a dish warm or melt butter or chocolate. As the cooking zone cools, the

power display will show **h**. The display switches off when the cooking zone has cooled sufficiently.

### Overheating protection

If the electronic elements overheat, the hob switches off automatically and **F** appears on the display, followed by a flashing number. When the temperature has reached a suitable level, this message disappears and the hob may be used again.

### Safety switch

The appliance has a safety switch which automatically switches the cooking zones off after they have been in operation for a certain amount of time at a particular power level. When the safety switch has been triggered, the display shows "0". For example: the right rear hotplate is set to 5 and will switch off after 5 hours of continuous operation, while the front left hotplate is set to 2 and will switch off after 8 hours.







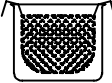

Power level	Maximum operating time in hours
1	9
2	8
3	7
4	6
5	5
6	4
7	3
8	2
9	1

### Buzzer

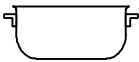
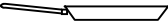
This can also indicate several irregularities:

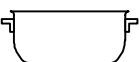
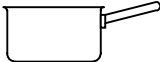
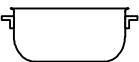
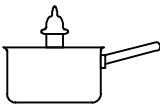
- An object (a pan, cutlery, etc.) has been placed on the control panel for more than 10 seconds.
- Something has been spilt on the control panel.
- A button has been pressed for too long. All of the above situations may cause the buzzer to sound. Remove the cause of the malfunction to stop the buzzer. If the cause of the problem is not removed, the buzzer will keep sounding and the hob will switch off.

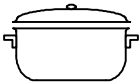
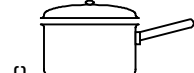
Practical cooking advice

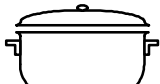
Very high-flame cooking	9	 Pressure cooking Pressure cooker	 Frying
	8	 Grilling	 Boiling
High-flame cooking	7	 Crêpes	 Cooking on a high flame and browning (roasts, steaks, escalopes, fish fillets, fried eggs)
Medium-flame cooking	6	 Fast thickening (liquid juices) Boiling water (pasta, rice, vegetables) Milk	
	5	 Slow thickening (dense juices)	
	4	 Bain-marie cooking	 Pressure cooking after whistle
Low-flame cooking	3	 Low-flame cooking (stews)	 Reheating dishes
Very low-flame cooking	2	 Chocolate sauce	 Keeping food hot

# Precautions and tips

! This appliance has been designed and manufactured in compliance with international safety standards. The following warnings are provided for safety reasons and must be read carefully.

 This appliance conforms to the following European Economic Community directives:  
- 2006/95/EEC dated 12/12/06 (Low Voltage) and subsequent amendments;  
- 89/336/EEC dated 03/05/89 (Electromagnetic Compatibility) and subsequent amendments;  
- 93/68/EEC dated 22/07/93 and subsequent amendments.

## General safety

! Make sure that the air inlet behind the fan grille is never obstructed. The built-in hob should, in fact, be provided with suitable ventilation for the cooling of the electronic components used in the appliance.

- The appliance was designed for domestic use inside the home and is not intended for commercial or industrial use.
- The appliance must not be installed outdoors, even in covered areas. It is extremely dangerous to leave the appliance exposed to rain and storms.
- Do not touch the appliance when barefoot or with wet or damp hands and feet.
- The appliance must be used by adults only for the preparation of food, in accordance with the instructions provided in this booklet. Do not use the hob as a worktop or chopping board.
- The glass ceramic hob is resistant to mechanical shocks, but it may crack (or even break) if hit with a sharp object such as a tool. If this happens, disconnect the appliance from the electricity mains immediately and contact a Service Centre.
- Ensure that power supply cables of other electrical appliances do not come into contact with the hot parts of the hob.
- Remember that the cooking zones remain relatively hot for at least thirty minutes after they have been switched off. An indicator light provides a warning when residual heat is present (*see Start-up and use*).
- Keep any object which could melt away from the hob, for example plastic and aluminium objects, or products with a high sugar content. Be especially careful when using plastic film and aluminium foil or packaging: if placed on surfaces which are still hot, they may cause serious damage to the hob.

- Always make sure that pan handles are turned towards the centre of the hob in order to avoid accidental burns.
- When unplugging the appliance, always pull the plug from the mains socket; do not pull on the cable.
- Never perform any cleaning or maintenance work without having disconnected the appliance from the electricity mains.
- The appliance should not be operated by people (including children) with reduced physical, sensory or mental capacities, by inexperienced individuals or by anyone who is not familiar with the product. These individuals should, at the very least, be supervised by someone who assumes responsibility for their safety or receive preliminary instructions relating to the operation of the appliance.
- Do not look at the halogen lamps in the cooking zones for long if they are present.
- Do not let children play with the appliance.



- When disposing of packaging material: observe local legislation so that the packaging may be reused.
- The European Directive 2002/96/EC relating to Waste Electrical and Electronic Equipment (WEEE) states that household appliances should not be disposed of using the normal solid urban waste cycle. Exhausted appliances should be collected separately in order to optimise the cost of re-using and recycling the materials inside the machine, while preventing potential damage to the atmosphere and to public health. The crossed-out dustbin is marked on all products to remind the owner of their obligations regarding separated waste collection. For further information relating to the correct disposal of exhausted household appliances, owners may contact the public service provided or their local dealer.

# Care and maintenance

GB

## Switching the appliance off

Disconnect your appliance from the electricity supply before carrying out any work on it.

## Cleaning the appliance

! Do not use abrasive or corrosive detergents (for example, products in spray cans for cleaning barbecues and ovens), stain removers, anti-rust products, powder detergents or sponges with abrasive surfaces: these may scratch the surface beyond repair.

! Never use steam cleaners or pressure cleaners on the appliance.

- It is usually sufficient simply to wash the hob using a damp sponge and dry it with absorbent kitchen towel.
- If the hob is particularly dirty, rub it with a special glass ceramic cleaning product, then rinse well and dry thoroughly.
- To remove more stubborn dirt, use a suitable scraper. Remove spills as soon as possible, without waiting for the appliance to cool, to avoid residues forming crusty deposits. You can achieve excellent results by using a rust-proof steel wire sponge - specifically designed for glass ceramic surfaces - soaked in soapy water.
- If any plastic or sugary substances are accidentally melted on the hob, remove them immediately with the scraper, while the surface is still hot.
- Once it is clean, the hob may be treated with a special protective maintenance product: the invisible film left by this product protects the surface from drips during cooking. This maintenance task should be carried out while the appliance is warm (not hot) or cold.
- Always remember to rinse the appliance well with clean water and dry it thoroughly: residues can become encrusted during subsequent cooking processes.

**Stainless steel frame** (only in models with outer frame)

Stainless steel can be marked by hard water which has been left on the surface for a long time, or by cleaning products containing phosphorus. After cleaning, it is advisable to rinse the surface well and dry it thoroughly. If water is spilt on the surface, dry it quickly and thoroughly.

! Some hobs have an aluminium frame which is similar to stainless steel. Do not use any cleaning or degreasing products which are not suitable for use with aluminium.

## Disassembling the hob

If it is necessary to disassemble the hob:

1. Loosen the screws fixing the alignment springs on each side.
2. Loosen the screws holding the fixing hooks in each corner.
3. Take the hob out of its installation cavity.

! Do not attempt to repair the appliance yourself. If the appliance breaks down, contact a Service Centre.

# Technical description of the models

This table provides a model-by-model list of the energy absorption values, type of heating elements and diameters of each cooking zone.

<b>Hobs</b>		
<b>NRO 642 D Z</b>		
<b>Cooking zone</b>	<b>Power (W)</b>	<b>Diameter (mm)</b>
Back Left	HD 2200/1000	210/140
Back Right	H 1400	160
Front Left	H 1200	145
Front Right	HD 1700/700	180/120
Total power	6500	

<b>Hobs</b>		
<b>NRO 841 O X</b>		
<b>Cooking zone</b>	<b>Power (W)</b>	<b>Diameter (mm)</b>
Back Left	H 2300	210
Centre Left	HO 2400/1500	170x260
Centre	H 1800	180
Front Right	H 1200	145
Total power	7700	

**Key:**

H = single highlight

HO = oval highlight

HD = double highlight