

ARU75BX-L

75cm Undermount Rangehood



 **ARISTON**



FEATURES & BENEFITS



1000m³/h Extraction

Removes cooking odours with ease



50/62/64 dB Noise Rating

Quiet operation makes this unit perfect for open plan kitchens.



LED Lighting

Giving extra light when needed in the kitchen.



3 Speed Settings

Depending on what you're cooking you can vary the amount of extraction as required.



5 YEAR WARRANTY on parts and labour.

TECHNICAL SPECIFICATIONS

Construction Type/Product Family	Undermount rangehood
Speed settings	3
Lighting type / Position	LED / Front
Control Type	Sliding switch
Colour	Stainless steel
Filter Type	Aluminium or Optional Carbon Filter
Motor	Single
dB Rating	50/62/64
Ducting diameter	150mm
Location & Length of Power Cable	
Electrical Connect Requirements	
Voltage (V)	
Frequency (Hz)	
Approval Certificates	CE

DIMENSIONS

Product Dimensions (W) x (H) x (D)	750 x 254 x 296
Package Dimensions (W) x (H) x (D)	
Built-In Hole Dimensions (W) x (D)	710 x 262
Weight	9kg

www.ariston.com.au

DISTRIBUTED BY ARISIT PTY LTD
40-50 Mark Anthony Drive,
Dandenong South VIC 3175
Ph: 1300 762 219
Fax: 03 9768 0838
Website: www.arisit.com

1A Howe Street,
Newton, Auckland NZ 1145
Ph: (09) 306 1020
Website: www.arisit.com



ARU75BX-L

75cm Undermount Rangehood



Product dimensions

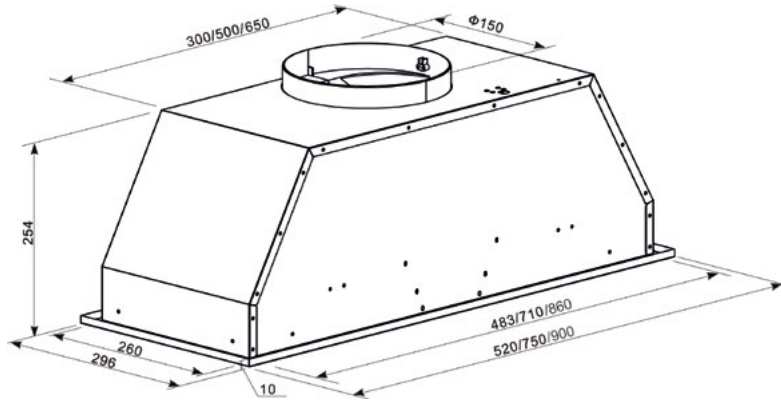

Rangehood/cooktop clearance

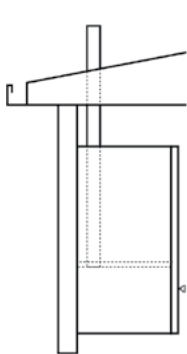
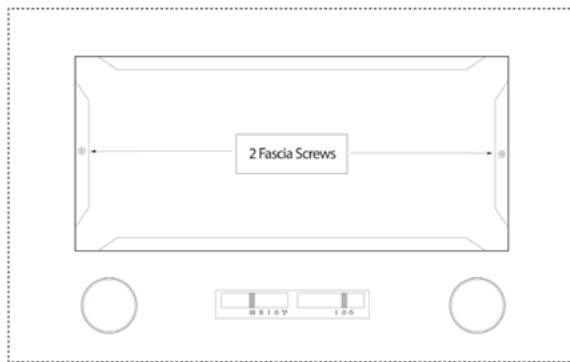
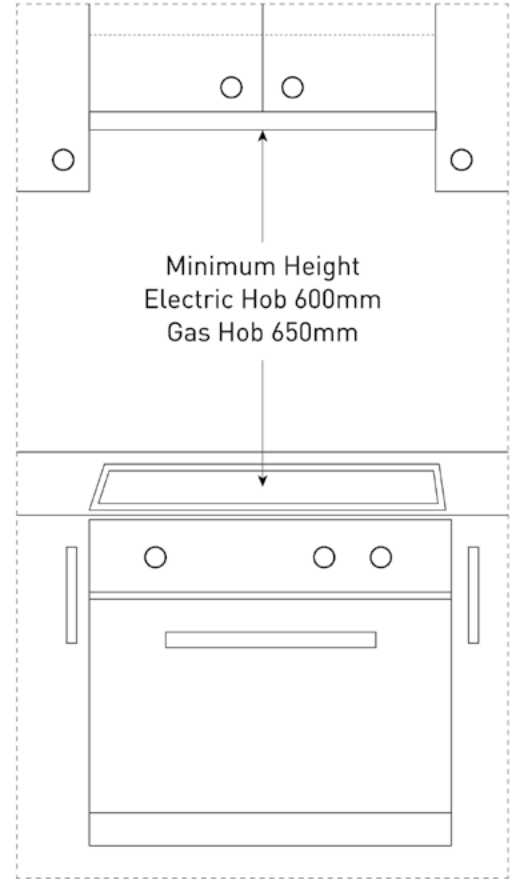

TOP DUCTING

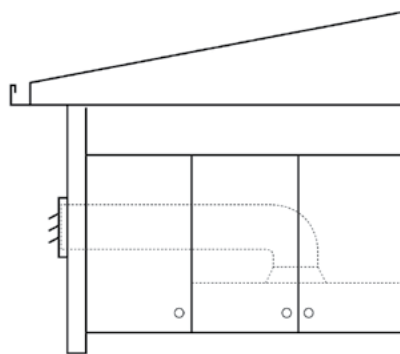

SIDE DUCTING

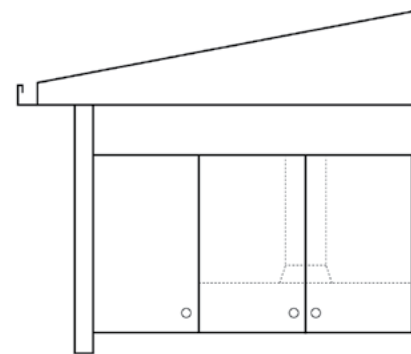

RE-CIRCULATING
(Carbon filter required)

WARNING: Technical specifications and product sizes can be varied by the manufacturer, without notice. Cut outs for appliances should only be by physical product measurements. The above is indicative only.

www.ariston.com.au

DISTRIBUTED BY ARISIT PTY LTD
40-50 Mark Anthony Drive,
Dandenong South VIC 3175
Ph: 1300 762 219
Fax: 03 9768 0838
Website: www.arisit.com

1A Howe Street,
Newton, Auckland NZ 1145
Ph: (09) 306 1020
Website: www.arisit.com

