

**EN** English

## Operating instructions

### **DISHWASHER - Contents**

Operating instructions, 1  
Precautions and advice, 2-3  
Product Data, 4  
Installation, 5-6  
Description of the appliance, 7  
Refined salt and rinse aid, 8  
Loading the racks, 9-10  
Detergent and dishwasher use, 11  
Wash cycles, 12  
Special wash cycles and options, 13  
Care and maintenance, 14  
Troubleshooting, 15  
Assistance, 16

# Precautions, advice and Assistance

EN

## EN Precautions and advice

 This appliance was designed and manufactured in compliance with international safety standards. The following information has been provided for safety reasons and should be read carefully.

Keep this instruction manual in a safe place for future reference. If the appliance is sold, given away or moved, make sure the manual is kept with the machine.

Read the instructions carefully, as they include important information on safe installation, use and maintenance.

This appliance was designed for domestic use or similar applications, for example:

- use by guests in hotels, motels and other residential settings;
- bed & breakfasts.

Remove the appliance from all packaging and make sure it was not damaged during transportation. If it was damaged, contact the retailer and do not proceed any further with the installation process.

### General safety

- This appliance should not be operated by children younger than 8 years, people with reduced physical, sensory or mental capacities, or inexperienced people who are not familiar with the product, unless they are given close supervision or instructions on how to use it safely and are made aware by a responsible person of the dangers its use might entail.
- Children must not play with the appliance.
- It is the user's responsibility to clean and maintain the appliance. Children should never clean or maintain it unless they are given supervision.
- The appliance was designed for domestic use inside the home and is not intended for commercial or industrial use.
- The appliance must be used to wash domestic crockery in accordance with the instructions in this manual.
- The appliance must not be installed outdoors, even in covered areas. It is extremely dangerous to leave the machine exposed to rain and storms.
- Do not touch the appliance when barefoot.
- When unplugging the appliance always pull the plug from the mains socket. Do not pull on the cable.

- The water supply tap must be shut off and the plug should be removed from the electrical socket at the end of every cycle and before cleaning the appliance or carrying out any maintenance work.
- The maximum number of place settings is shown in the product sheet.
- If the appliance breaks down, do not under any circumstances touch the internal parts in an attempt to perform the repair work yourself.
- Do not lean or sit on the open door: this may cause the appliance to overturn.
- The door should not be left open as it may create a dangerous obstacle.
- **WARNING:** Some dishwasher detergents are strongly alkaline. They can be extremely dangerous if swallowed. Avoid contact with the skin and eyes and keep children away from the dishwasher when the door is open. Check that the detergent receptacle is empty after completion of the wash cycle.
- The packaging material should not be used as a toy.
- Knives and other utensils with sharp edges must be placed either with the points/blades facing downwards in the cutlery basket or horizontally on the tip-up compartments or in the tray/third basket, if available.
- Connect the appliance to the water mains using the new supply hose provided with the appliance. Do not re-use the old hose.
- Install the back side of a free-standing dishwasher against a wall.

### Disposal

- To dispose of any packaging materials, follow local legislation so that the packagings may be reused.
- The European Directive 2012/19/EU relating to Waste Electrical and Electronic Equipment (WEEE) states that household appliances should not be disposed of using the normal solid urban waste cycle. Exhausted appliances should be collected separately in order to optimise the cost of reusing and recycling the materials inside the machine, while preventing potential damage to the atmosphere and public health. The crossed-out dustbin symbol shown on all products reminds the owners of their obligations regarding separated waste collection.  
For further information relating to the correct

disposal of household appliances, owners may contact the relevant public authority or the local appliance dealer.

## **Saving energy and respecting the environment**

### **Saving water and energy**

- Only begin a wash cycle when the dishwasher is full. While waiting for the dishwasher to be filled, prevent unpleasant odours with the Soak cycle (*if available, see Wash Cycles*).
- Select a wash cycle that is suited to the type of crockery and to the soil level using the Table of Wash Cycles:
  - For dishes with a normal soil level, use the Eco wash cycle, which guarantees low energy and water consumption levels.
  - If the load is smaller than usual activate the Half Load option (*see Special wash cycles and options, if available*).
- If your electricity supply contract gives details of electricity-saving time bands, run the wash cycles when electricity prices are lower. The Delayed Start option can help you organise the wash cycles accordingly (*see Special wash cycles and options, if available*).

# Product Data (product fiche)

EN

Product Fiche	
Brand	<b>ARISTON</b>
Model	<b>LFB 5M019</b>
Rated capacity in standard place settings (1)	14
Energy Star Rating	3
Comparative Energy Consumption (kWh/year), CEC	325
Energy Total (kWh), $E_t$	0.860
Average measured Standby Power (W), $P_S$	1,39
Primary Total Water Volume (L)	12.0
Water Star Rating	4.5
Noise in dB(A) Re 1pW	49
Built-in model	No
<b>NOTES</b>	
1) The information on the label and fiche relates to the standard cleaning cycle, this programme is suitable to clean normally soiled tableware and it is the most efficient programme in terms of combined energy and water consumption. The standard cleaning cycle corresponds to the Normal cycle.	

**⚠** If the appliance must be moved at any time, keep it in an upright position; if absolutely necessary, it may be tilted onto its back.

## Connecting the water supply

**⚠** Adaptation of the water supply for installation should only be performed by a qualified technician.

The water inlet and outlet hoses may be positioned towards the right or the left in order to achieve the best possible installation.

Make sure the dishwasher does not bend or squash the hoses.

## Connecting the water inlet hose

- To a 3/4" gas cold or hot water connection point (max. 60°C).
- Run the water until it is perfectly clear.
- Screw the inlet hose tightly into position and turn off the tap.

**⚠** If the inlet hose is not long enough, contact a specialist store or an authorised technician (*see Assistance*).

**⚠** The water pressure must be within the values indicated in the Technical Data table - otherwise the dishwasher may be function properly.

**⚠** Make sure the hose is not bent or compressed.

## Connecting the water outlet hose

Connect the outlet hose to a drain duct with a minimum diameter of 2 cm. (A)

The outlet hose connection must be at a height ranging from 40 to 80 cm from the floor or surface where the dishwasher rests.

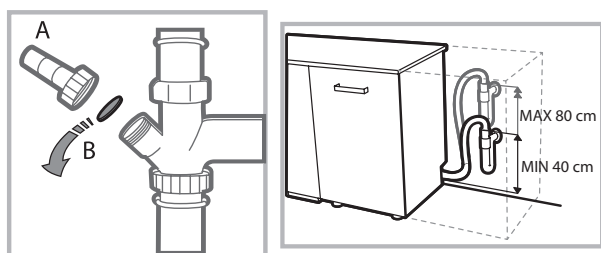

Before connecting the water outlet hose to the sink drain, remove the plastic plug (B).

## Anti-flooding protection

To ensure floods do not occur, the dishwasher:

- is provided with a special system which blocks the water supply in the event of anomalies or leaks from inside the appliance.

Some models are also equipped with the supplementary safety device **New Acqua Stop\***, which guarantees anti-flooding protection even in the event of a supply hose rupture.



## WARNING: HAZARDOUS VOLTAGE!

Under no circumstances should the water inlet hose be cut as it contains live electrical parts.

## Electrical connection

Before inserting the plug into the electrical socket, make sure that:

- The socket is **earthed** and complies with current regulations;
- the socket can withstand the maximum load of the appliance as shown on the data plate located on the inside of the door (*see chapter Description of the appliance*);
- The power supply voltage falls within the values indicated on the data plate on the inside of the door.
- The socket is compatible with the plug of the appliance. If this is not the case, ask an authorised technician to replace the plug (*see Assistance*). Do not use extension cables or multiple sockets.

**⚠** Once the appliance has been installed, the power supply cable and the electrical socket should be easily accessible.

**⚠** The cable should not be bent or compressed.

**⚠** If the power supply cable is damaged, have it replaced by the manufacturer or its authorised Technical Assistance Service in order to prevent all potential hazards. (*See Assistance*)

**⚠** The Company shall not be held responsible for any incidents, if these regulations are not observed.

## Positioning and levelling

1. Position the dishwasher on a level sturdy floor. If the floor is uneven, the front feet of the appliance may be adjusted until it reaches a horizontal position. If the appliance is levelled correctly, it will be more stable and much less likely to move or cause vibrations and noise while it is operating.

2. Before recessing the dishwasher, stick the adhesive transparent strip\* under the wooden shelf in order to protect it from any condensation which may form.

3. Place the dishwasher so that its sides or back panel are in contact with the adjacent cabinets or the wall. This appliance can also be recessed under a single worktop\* (*see the Assembly instruction sheet*).

4\*. To adjust the height of the rear foot, turn the red hexagonal bushing on the lower central part at the front of the dishwasher using a hexagonal spanner with an opening of 8 mm. Turn the spanner in a clockwise direction to increase the height and in an anticlockwise direction to decrease it. (*see Building-in instruction sheet attached to the documentation*)

\* Only available in selected models.

### Avvertenze per il primo lavaggio

Dopo l'installazione, rimuovere i tamponi posizionati sui cesti e gli elastici di trattenimento sul cesto superiore (*dove presenti*).

### Impostazioni addolcitore acqua

Prima di avviare il primo lavaggio, impostare il livello di durezza dell'acqua di rete. (*vedi capitolo Brillantante e sale rigenerante*)

Il primo caricamento del serbatoio dell'addolcitore deve avvenire con acqua, poi introdurre circa 1 Kg. di sale; è normale che l'acqua fuoriesca.

Far partire un ciclo di lavaggio subito dopo.

Usare solo sale specifico per lavastoviglie.



Dopo il caricamento la spia MANCANZA SALE\* si spegne.

 Il mancato riempimento del contenitore del sale, può provocare il danneggiamento del dolcificatore dell'acqua e dell'elemento riscaldante.

La macchina, è dotata di segnali acustici/toni (*secondo il modello di lavastoviglie*) che avvisano dell'avvenuto comando: **accensione, fine ciclo ecc..**

I simboli/spie/led luminosi presenti sul pannello comandi/display, possono variare di colore, pulsare o essere a luce fissa. (*secondo il modello di lavastoviglie*).

Il display\*, visualizza informazioni utili relative al tipo di ciclo impostato, alla fase di lavaggio/asciugatura, al tempo residuo, alla temperatura ecc... ecc...

Technical data	
<b>Dimensions</b>	width 60 cm height 85 cm depth 60 cm
<b>Capacity</b>	14 standard place-settings
<b>Water supply pressure</b>	0,05 ÷ 1MPa (0.5 ÷ 10 bar) 7,25 – 145 psi
<b>Power supply voltage</b>	See appliance data plate
<b>Total absorbed power</b>	See appliance data plate
<b>Fuse</b>	See appliance data plate
 	This dishwasher conforms to the following European Community Directives: -2006/95/EC (Low Voltage) -2004/108/EC (Electromagnetic Compatibility) -2009/125/EC (Comm. Reg. 1016/2010) (Ecodesign) -97/17/EC (Labelling) -2012/19/EU Waste Electrical and Electronic Equipment (WEEE)

\* Only available in selected models.

# Description of the appliance

## Overall view

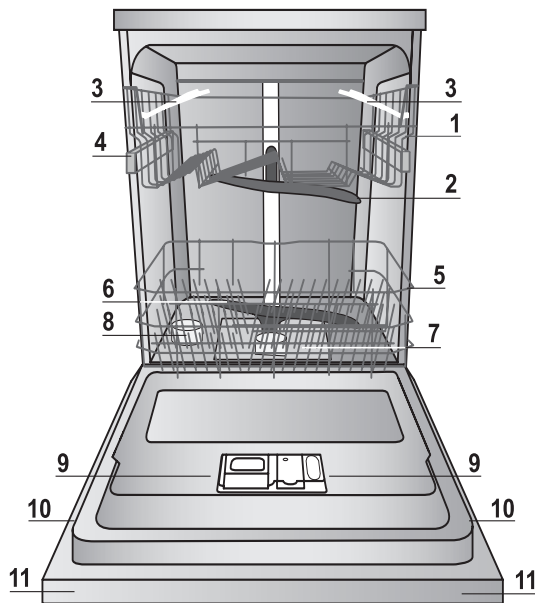

- 1. Upper rack
- 2. Top sprayer arm
- 3. Tip-up compartments
- 4. Rack height adjuster
- 5. Lower rack
- 6. Bottom sprayer arm
- 7. Washing filter
- 8. Salt dispenser
- 9. Detergent and rinse aid dispenser
- 10. Data plate
- 11. Control panel\*\*\*

## Control panel

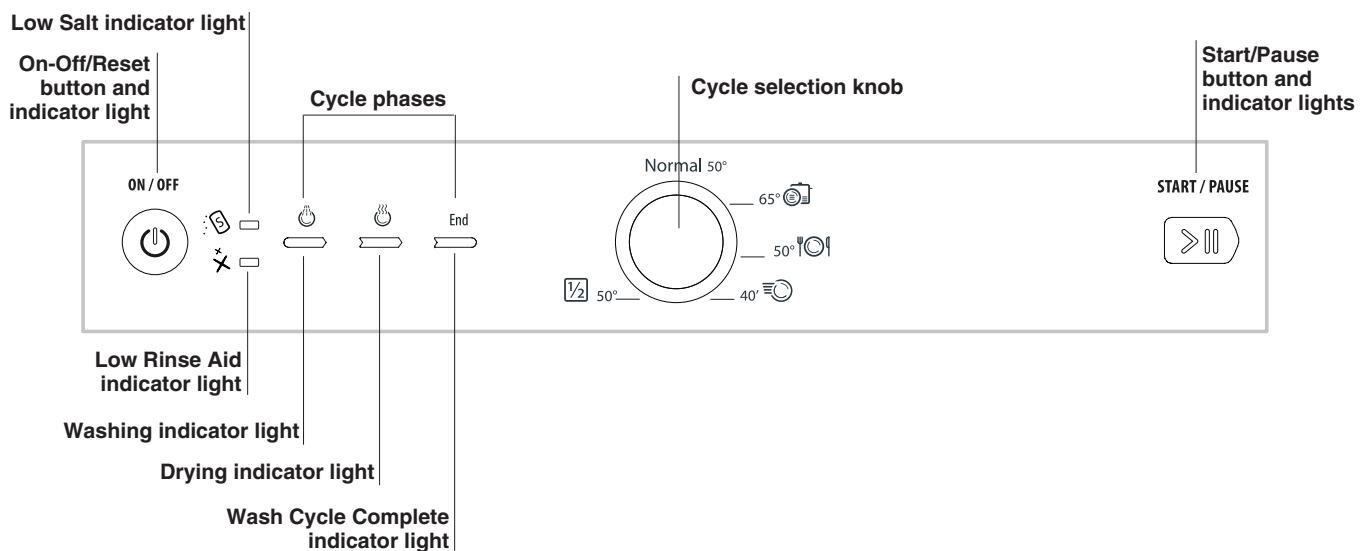

\*\*\* Only in completely built-in models. \* Only available in selected models.

The number and type of wash cycles and options may vary depending on the dishwasher model.

# Refined salt and rinse aid

EN

**⚠** Only use products which have been specifically designed for dishwashers. Do not use table salt or industrial salt. Follow the instructions given on the packaging.

**⚠** If you are using a multi-function product, we recommend that you add salt in any case, especially if the water is hard or very hard. (Follow the instructions given on the packaging.)

**⚠** If you do not add salt or rinse aid, the **LOW SALT\*** and **LOW RINSE AID\*** indicator lights will remain lit.

## Measuring out the refined salt

The use of salt prevents the formation of LIMESCALE on the dishes and on the machine's functional components.

- It is important that the salt dispenser be never empty.
- It is important to set the water hardness.

The salt dispenser is located in the lower part of the dishwasher (see *Description*) and should be filled:

- When the LOW RINSE AID indicator light in the control panel is lit\*;
- When the green float\* on the cap of the salt dispenser is no longer visible.
- See autonomy in the water hardness table.

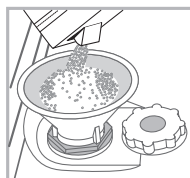

1. Remove the lower rack and unscrew the container cap (anticlockwise).
2. Only the first time you do this: fill the water dispenser up to the edge.
3. Position the funnel (see *figure*) and fill the salt container right up to its edge (approximately 1 kg); it is not unusual for a

little water to leak out.

4. Remove the funnel and wipe any salt residue away from the opening; rinse the cap under running water and then screw it on. It is advisable to perform this procedure every time you add salt to the container.

Make sure the cap is screwed on tightly, so that no detergent can get into the container during the wash cycle (this could damage the water softener beyond repair).

**⚠** Whenever you need to add salt, we recommend carrying out the procedure before the washing cycle is started.

## Setting the water hardness

For perfect water softener operation, it is essential that the adjustment be based on the water hardness in your house. Ask your local water supplier for this information. The factory setting is for medium water hardness.

- Switch the dishwasher on using the On/Off button.
- Switch it off using the On/Off button
- Press and hold the START/PAUSE button for 5 seconds.
- Switch it on using the On/Off button
- The salt indicator light flashes (as many times as the current selection.)
- Set the knob to the desired hardness level number (see *Table on water hardness.*)

- Switch it off using the On/Off button

• Setting is complete!

Even if using multi-functional tablets, the salt dispenser should still be filled.

Water Hardness Table				Average salt dispenser capacity duration**
level	°dH	°fH	mmol/l	months
1	0 - 6	0 - 10	0 - 1	7 months
2	6 - 11	11 - 20	1,1 - 2	5 months
3	12 - 17	21 - 30	2,1 - 3	3 months
4	17 - 34	31 - 60	3,1 - 6	2 months
5*	34 - 50	61 - 90	6,1 - 9	2/3 weeks

For values between 0°f and 10°f, we do not recommend the use of salt.  
\* a setting of 5 may increase cycle duration.  
\*\* 1 wash cycle per day.

(°dH = hardness measured in German degrees - °f = hardness measured in French degrees - mmol/l = millimoles per litre)

## Measuring out the rinse aid

Rinse aid makes dish DRYING easier. The rinse aid dispenser should be filled:

- When the LOW RINSE AID indicator light on the panel/display is lit\*;
- When the dark optical indicator\* on the dispenser door "D" becomes transparent.

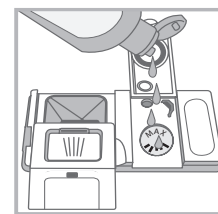
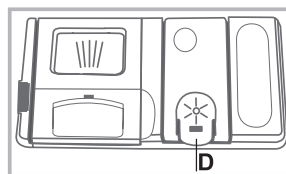

1. Open the dispenser "D" by pressing and pulling up the tab on the lid;
2. Carefully introduce the rinse aid as far as the maximum reference notch of the filling space - avoid spilling it. If this happens, clean the spill immediately with a dry cloth.
3. Press the lid down until you hear a click to close it.

**NEVER pour the rinse aid directly into the appliance tub.**

## Rinse-aid dispenser setting

If you are not completely satisfied with the drying results, you can adjust the quantity of rinse aid.

- Switch the dishwasher on using the On/Off button.
- Switch it off using the On/Off button
- Press the START/PAUSE button three times
- Switch it on using the On/Off button
- Everything is off
- Set the knob to the level number of rinse aid quantity to be supplied.
- Switch it off using the On/Off button
- Setting is complete!

If the rinse aid level is set to ZERO (ECO), no rinse aid will be supplied. The LOW RINSE AID indicator light will not be lit if you run out of rinse aid.

A maximum of 4 levels can be set according to the dishwasher model. The factory setting is for a medium level.

- If you see bluish streaks on the dishes, set a low number (1-2).
- If there are drops of water or limescale marks on the dishes, set a high number (3-4).

\* Only available in selected models.



# Loading the racks

## Tips

Before loading the racks, remove all food residues from the crockery and empty liquids from glasses and containers. **No preventive rinsing is needed under running water.**

Arrange the crockery so that it is held in place firmly and does not tip over; and arrange the containers with the openings facing downwards and the concave/convex parts placed obliquely, thus allowing the water to reach every surface and flow freely. Make sure that the lids, handles, trays and frying pans do not prevent the sprayer arms from rotating. Place any small items in the cutlery basket.

Since plastic dishes and non-stick frying pans usually retain more water drops, their drying will be not so good as that of ceramic or stainless-steel dishes.

Lightweight items such as plastic containers should be placed in the upper rack and arranged so that they cannot move.

After loading the appliance, make sure that the sprayer arms can rotate freely.

## Lower rack

The lower rack can hold pans, lids, dishes, salad bowls, cutlery etc. Large plates and lids should ideally be placed at the sides.

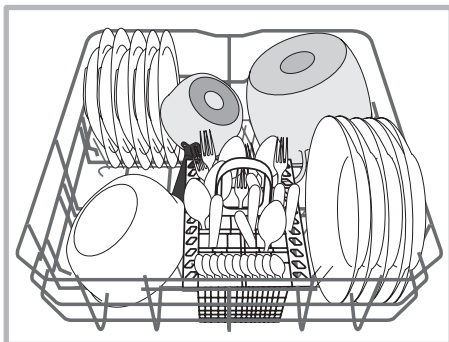
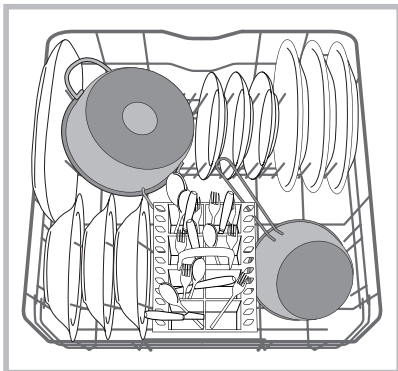

Very soiled dishes and pans should be placed in the lower rack because in this sector the water sprays are stronger and allow a higher washing performance.

Several dishwasher models are fitted with tip-up sectors\*. They can be used in a vertical position when arranging dishes or in a horizontal position (lower) to load pans and salad bowls easily.

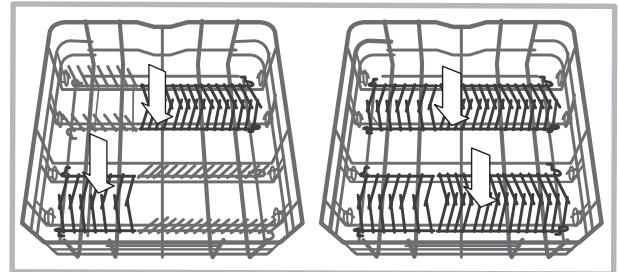

## Cutlery basket

The modular basket is equipped with top grilles for improved cutlery arrangement. The cutlery basket should be positioned **only** at the front of the lower rack

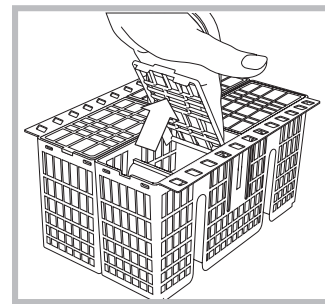

 Knives and other utensils with sharp edges must be placed in the cutlery basket with the points facing downwards or they must be positioned horizontally in the tip-up compartments on the upper rack

## Upper rack

Load this rack with delicate and lightweight crockery such as glasses, cups, saucers and shallow salad bowls.

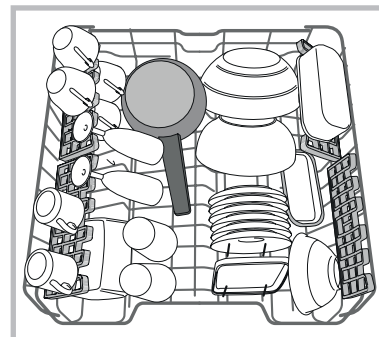

Several dishwasher models are fitted with tip-up sectors\*. They can be used in a vertical position when arranging tea/dessert saucers or in a lower position to load bowls and food containers.

\*Only available in selected models with different numbers and positions.

### Tip-up compartments with adjustable position

The side tip-up compartments can be positioned at three different heights to optimize the arrangement of crockery inside the rack.

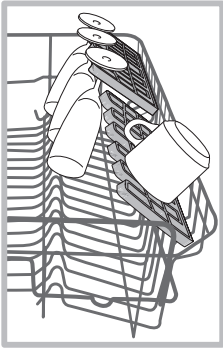

Wine glasses can be placed safely in the tip-up compartments by inserting the stem of each glass into the corresponding slots.

For optimum drying results incline the tip-up compartments more. To change the inclination, pull up the tip-up compartment, slide it slightly and position it as you wish.

### Cutlery tray\*

Some dishwasher models are fitted with a sliding tray which can be used to hold serving utensils or small cups. For optimum washing performance avoid positioning bulky crockery directly below the tray. The cutlery tray can be removed (see Figure).

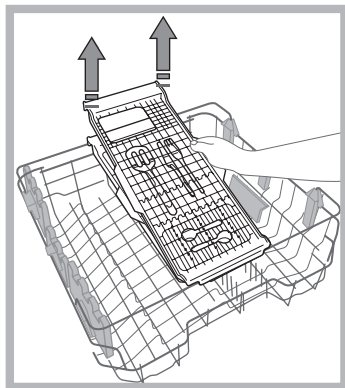
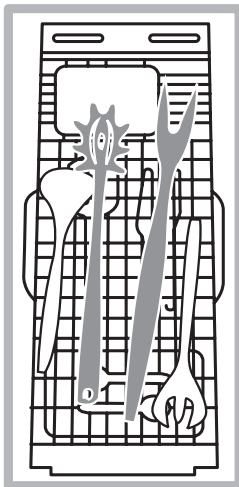

The upper rack can be adjusted for height based on requirements: high position to place bulky crockery in the lower rack and low position to make the most of the tip-up compartments/sectors by creating more space upwards.

### Adjusting the height of the upper rack

In order to make it easier to arrange the crockery, the upper rack may be moved to a higher or lower position.

**The height of the upper rack should be adjusted WHEN THE RACK IS EMPTY.**

**NEVER raise or lower the rack on one side only.**

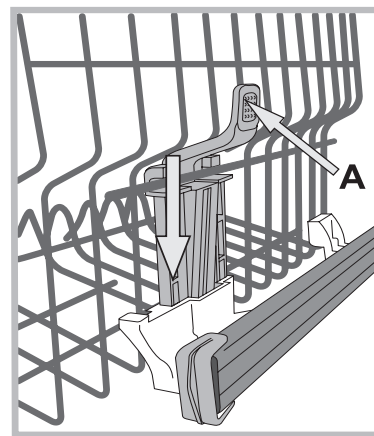

If the rack is equipped with a **Lift-Up device\*** (see figure), lift it up by holding its sides. To restore the lower position, press the levers (**A**) at the sides of the rack and follow the rack down.

### Unsuitable crockery

- Wooden crockery and cutlery.
- Delicate decorated glasses, artistic handicraft and antique crockery. Their decorations are not resistant.
- Parts in synthetic material which do not withstand high temperatures.
- Copper and tin crockery.
- Crockery soiled with ash, wax, lubricating grease or ink.

The colours of glass decorations and aluminium/silver pieces can change and fade during the washing process. Some types of glass (e.g. crystal objects) can become opaque after a number of wash cycles too.

### Damage to glass and crockery

Caused by:

- Type of glass and glass production process.
- Chemical composition of detergent.
- Water temperature of rinse cycle.

Tips:

- Only use glasses and porcelain guaranteed by the manufacturer as dishwasher safe.
- Use a delicate detergent suitable for crockery.
- Collect glasses and cutlery from the dishwasher as soon as the wash cycle is over.

\* Only available in selected models.

# Start-up and use

## Starting the dishwasher

1. Press the ON/OFF button: all the indicator lights on the control panel will light up for a few seconds.
2. Open the door and pour in a suitable amount of detergent (*see Measuring out the detergent*).
3. Load the racks (*see Loading the racks*) and shut the door.
4. Select the wash cycle by turning the WASH CYCLE SELECT knob clockwise: align the notch on the knob with the number or symbol representing the desired wash cycle. The START/PAUSE indicator light will flash.
5. Select the wash options\* (*see Special Wash Cycles and Options*).
6. Start the cycle by pressing the START button; the indicator light will stop flashing and stay lit in a fixed manner. The indicator light corresponding to the wash phase will switch on, signalling that the wash cycle has begun.
7. At the end of the wash cycle the END indicator light will switch on (fixed light). Switch off the appliance by pressing the ON/OFF button.
8. Wait for a few minutes before removing the crockery in order to avoid burns. Unload the racks, beginning with the lower level.

 **The machine will switch off automatically during long periods of inactivity in order to minimise electricity consumption.**

## Changing a wash cycle in progress

If a mistake was made in the wash cycle selection process, it is possible to change the cycle provided that it has only just begun: once the wash cycle has started, in order to change the wash cycle switch off the machine by pressing and holding the ON/OFF/Reset button. Switch it back on using the same button and select the desired wash cycle and options.

## Adding extra crockery

Press the Start/Pause button and open the door, taking care to avoid the escaping steam, and place the crockery inside the dishwasher. Press the Start/Pause button: The cycle will start again after a long beep has been emitted.

 If the delayed start has been set, at the end of the countdown the wash cycle will not start. It will stay in Pause mode.

 Press the Start/Pause button to pause the machine; the wash cycle is stopped.

At this stage it is not possible to change the wash cycle.

## Accidental interruptions

If the door is opened during the wash cycle or there is a power cut, the cycle stops. It starts again from the point at which it was interrupted once the door has been shut or the electricity supply is restored.

\* Only available in selected models.

## Measuring out the detergent

**A good wash result also depends on the correct amount of detergent being used. Exceeding the stated amount does not result in a more effective wash and increases environmental pollution.**

**Based on how soiled the items are, the amount can be adjusted to individual cases using powder or liquid detergent.**

**In the case of normally soiled items, use approximately either 35 gr (powder detergent) or 35 ml (liquid detergent). If tablets are used, one tablet will be enough.**

**If the crockery is only lightly soiled or if it has been rinsed with water before being placed in the dishwasher, reduce the amount of detergent used accordingly.**

**For good washing results also follow the instructions shown on the detergent box.**

**For further questions please ask the detergent producers.**

**To open the detergent dispenser use the opening device "A".**

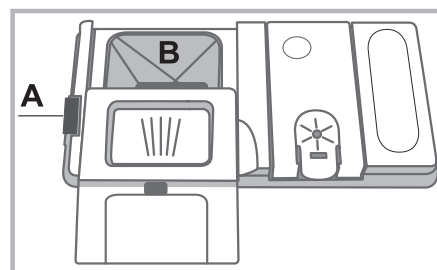

**Introduce the detergent into the dry dispenser "B" only. Place the amount of detergent for pre-washing directly inside the tub.**

1. When measuring out the detergent refer to the Table of wash cycles to add the proper quantity. Compartment **B** comprises a level showing the maximum quantity of liquid or powder detergent that can be added to each cycle.

2. Remove detergent residues from the edges of the dispenser and close the cover until it clicks.

3. Close the lid of the detergent dispenser by pulling it up until the closing device is secured in place.

The detergent dispenser automatically opens up at the right time according to the wash cycle.

If all-in-one detergents are used, we recommend using the TABS option, because it adjusts the cycle so that the best washing and drying results are always achieved.

 **Only use detergent which has been specifically designed for dishwashers.**

**DO NOT USE** washing up liquid.

**Using excessive detergent may result in foam residues remaining in the machine after the cycle has ended.**





**To achieve the best washing and drying results, the combined use of detergent, rinse aid liquid and refined salt is required.**

**We recommend using detergents that do not contain phosphates or chlorine, as these products are harmful to the environment.**

# Wash cycles

EN

 The number and type of wash cycles and options may vary depending on the dishwasher model.

Wash cycle	Wash cycle which include drying	Options	Approximate duration of wash cycles h:min.	Water consumption (l/cycle)	Energy consumption (kWh/cycle)
1. Normal *	Yes	No	02:40'	12	0,86
2. Intensive 	Yes	No	02:30'	16,5	1,7
3. Daily 	No	No	01:00'	11,5	1,1
4. Express 40' 	No	No	00:40'	9	0,95
5. Half Load 	Yes	No	01:20'	12	1,1

## Instructions on wash-cycle selection and detergent dosage

1. The NORMAL wash cycle is the standard cycle to which the energy label data refers. It can be used to wash crockery with a normal soil level and is the most efficient cycle in terms of energy and water consumption for this type of crockery. Open the door at end of programme by 50mm to assist in drying. Add detergent amounts for cycle: 29 gr/ml + 6 gr/ml\*\* – 1 Tab (*\*\*Quantity of pre-washing detergent*)
2. Heavily soiled dishes and pans (not to be used for delicate items). 35 gr/ml – 1 Tab
3. Limited quantity of daily soiling (ideal for 4 place settings) 25 gr/ml – 1 Tab
4. Fast cycle to be used for slightly dirty dishes (ideal for 2 place settings) 25 gr/ml – 1 Tab
5. Ideal cycle for small loads of crockery with a normal soil level. 25 gr/ml – 1 Tab

### Notes:

Optimum performance levels when using the “Daily” and “Express 40’ ” cycles can be achieved by respecting the specified number of place settings.

To reduce consumption even further, only run the dishwasher when is full.

\* The Normal wash cycle adheres to the regulation standard **AS/NZS 2007**. Although it has a longer duration than other wash cycles it uses less energy and is less harmful to the environment.

**Note for Test Laboratories:** for information on comparative EN testing conditions, please send an email to the following address: [assistenza\\_en\\_lvs@indesitcompany.com](mailto:assistenza_en_lvs@indesitcompany.com)

## Shutting off the water and electricity supplies

- Turn off the water tap after every wash cycle to avoid leaks.
- Always unplug the appliance when cleaning it and when performing maintenance work.

## Cleaning the dishwasher

- The external surfaces of the machine and the control panel can be cleaned using a non-abrasive cloth which has been dampened with water. Do not use solvents or abrasive products.
- Any marks on the inside of the appliance may be removed using a cloth dampened with water and a little vinegar.

## Preventing unpleasant odours

- Always keep the door of the appliance ajar in order to avoid moisture from forming and being trapped inside the machine.
- Clean the seals around the door and detergent dispensers regularly using a damp sponge. This will avoid food becoming trapped in the seals, which is the main cause behind the formation of unpleasant odours.

## Cleaning the sprayer arms

Food residue may become encrusted onto the sprayer arms and block the holes used to spray the water. It is therefore recommended that you check the arms from time to time and clean them with a small non-metallic brush.

The two sprayer arms may both be removed.

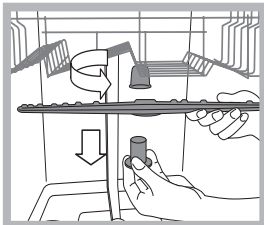

To remove the upper sprayer arm, turn the plastic locking ring in an anti-clockwise direction. The upper sprayer arm should be replaced so that the side with the greater number of holes is facing upwards.

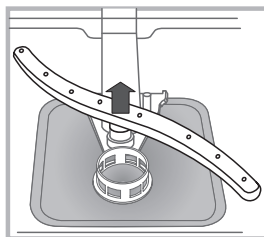

The lower sprayer arm can be removed by pressing on the side tabs and pulling it upwards.

## Cleaning the water inlet filter\*

If the water hoses are new or have not been used for an extended period of time, let the water run to make sure it is clear and free of impurities before performing the necessary connections. If this precaution is not taken, the water inlet could become blocked and damage the dishwasher.

- ⚠ Clean the water inlet filter at the tap outlet regularly.
  - Turn off the water tap.
  - Unscrew the end of the water inlet hose, remove the filter and clean it carefully under running water.
  - Re-place the filter and screw the water hose back into position.

## Cleaning the filters

The filter assembly consists of three filters which remove food residues from the washing water and then recirculate the water. They should be cleaned if you wish to achieve the best results in every wash.

- ⚠ Clean the filters regularly.
  - ⚠ The dishwasher should not be used without filters or if the filter is loose.
- After several washes, check the filter assembly and if necessary clean it thoroughly under running water, using a non-metallic brush and following the instructions below:
    1. Turn the cylindrical filter **C** in an anti-clockwise direction and pull it out (fig. 1).
    2. Remove the cup filter **B** by exerting a slight pressure on the side flaps (fig. 2);
    3. Slide out the stainless-steel plate filter **A**. (fig. 3).
    4. Inspect the trap and remove any food residues. **NEVER REMOVE** the wash-cycle pump protection (black detail) (fig. 4).

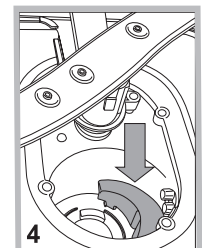
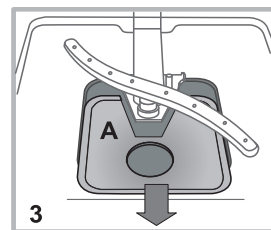
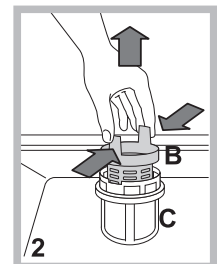
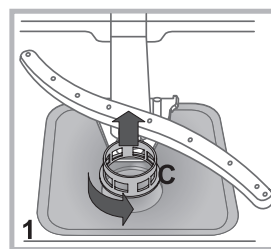

After cleaning the filters, re-place the filter assembly and fix it in position correctly; this is essential for maintaining the efficient operation of the dishwasher.

## Leaving the machine unused for extended periods

- Disconnect the appliance from the electricity supply and shut off the water tap.
- Leave the door of the appliance ajar.
- When you return, run a wash cycle when the dishwasher is empty.

\* Only available in selected models.

# Troubleshooting

EN

Whenever the appliance fails to work, check for a solution from the following list before calling for Assistance.

Problem:	Possible causes / Solutions:
<b>The dishwasher does not start or cannot be controlled.</b>	<ul style="list-style-type: none"> <li>• The water supply tap is not turned on.</li> <li>• Switch off the appliance by pressing the ON/OFF button, switch it back on after approximately one minute and reset the wash cycle.</li> <li>• The appliance has not been plugged in properly or another electricity socket should be used.</li> <li>• The dishwasher door has not been closed properly.</li> </ul>
<b>The door won't close.</b>	<ul style="list-style-type: none"> <li>• Make sure that the racks were inserted all the way.</li> <li>• The lock was released. Strongly push the door until a "clacking" noise is heard.</li> </ul>
<b>No water drain out of the dishwasher.</b>	<ul style="list-style-type: none"> <li>• The wash cycle has not finished yet.</li> <li>• The water drain hose is bent (<i>see Installation</i>).</li> <li>• The drain duct is clogged up.</li> <li>• The filter is clogged up with food residues.</li> <li>• Check the height of the drain hose.</li> </ul>
<b>The dishwasher makes excessive noise.</b>	<ul style="list-style-type: none"> <li>• The dishes are rattling against each other or against the spray arms. Place the dishes properly and make sure the spray arms can rotate freely.</li> <li>• Too much foam: the detergent has not been measured out correctly or it is not suitable for use in dishwashers. (<i>See Detergent and dishwasher use.</i>) Do not prewash the dishes by hand.</li> </ul>
<b>The dishes and glasses are covered in a white film or limescale deposits.</b>	<ul style="list-style-type: none"> <li>• No refined salt.</li> <li>• Water hardness adjustment is not suitable: increase the relevant values. (<i>See Refined salt and rinse aid.</i>)</li> <li>• The salt and rinse-aid dispenser cap has not been closed properly.</li> <li>• The rinse aid has been used up or the dosage is too low.</li> </ul>
<b>The dishes and glasses are streaked or have a bluish tinge.</b>	<ul style="list-style-type: none"> <li>• The rinse aid dosage is too high.</li> </ul>
<b>The crockery has not been dried properly.</b>	<ul style="list-style-type: none"> <li>• A wash cycle without a drying programme has been selected.</li> <li>• The rinse aid has been used up. (<i>See Refined salt and rinse aid.</i>)</li> <li>• The rinse aid dispenser setting is not suitable.</li> <li>• The crockery is made from non-stick material or plastic; the presence of water drops is normal.</li> </ul>
<b>The dishes are not clean.</b>	<ul style="list-style-type: none"> <li>• The crockery has not been arranged properly.</li> <li>• The spray arms cannot rotate freely, being hindered by the dishes.</li> <li>• The wash cycle is too gentle (<i>see Wash Cycles</i>).</li> <li>• Too much foam: the detergent has not been measured out correctly or it is not suitable for use in dishwashers. (<i>See Detergent and dishwasher use.</i>)</li> <li>• The lid on the rinse aid compartment has not been closed correctly.</li> <li>• The filter is dirty or clogged up (<i>see Care and maintenance.</i>)</li> <li>• The refined salt level is low (<i>see Rinse aid and salt</i>).</li> <li>• Make sure that the height of the dishes is compatible with the rack adjustment.</li> <li>• The holes in the sprayer arms are clogged up. (<i>See Care and maintenance.</i>)</li> </ul>
<b>The dishwasher won't load any water.</b> It is bocked with flashing lights.	<ul style="list-style-type: none"> <li>• There is no water in the mains supply or the tap is shut off.</li> <li>• The water inlet hose is bent (<i>see Installation</i>).</li> <li>• The filters are clogged up: they need cleaning. (<i>See Care and maintenance.</i>)</li> <li>• The drain duct is clogged up: it needs cleaning.</li> <li>• After checking and cleaning, switch the dishwasher on and off and start a new wash cycle.</li> <li>• If the problem persists, turn off the water tap, remove the plug and call the Service Centre.</li> </ul>

\* Only available in selected models.

## Assistance

### Before contacting Assistance:

- Check whether the problem can be resolved using the Troubleshooting guide (*see Troubleshooting*).
- Restart the programme to check whether the problem has ceased to exist.
- If the problem persists, contact the Authorised Technical Assistance Service.

 **Never use the services of unauthorised technicians.**

### Please have the following information to hand:

- The type of malfunction.
- The appliance model (Mod.).
- The serial number (S/N).

This information can be found on the appliance data plate (*see Description of the appliance*).

### Indesit Priority Service

Australia Phone: 1300 055 518

Australia Email: [servicesupport@indesit.net.au](mailto:servicesupport@indesit.net.au)

New Zeland Phone: 0800 367 835

New Zeland Email: [parts@eurotechdesign.co.nz](mailto:parts@eurotechdesign.co.nz)

### Genuine Accessories & Spare Parts

Australia Phone: 02 97143434

Australia Email: [spareparts@indesit.net.au](mailto:spareparts@indesit.net.au)

New Zeland Phone: 09 307 42 05 / 0800 367 835

New Zeland Email: [parts@eurotechdesign.co.nz](mailto:parts@eurotechdesign.co.nz)

### AUSTRALIA

BUSH AUSTRALIA PTY LIMITED

46 Buffalo Road, Gladesville

NSW 2111, Australia

Email: [salesinfo@indesit.net.au](mailto:salesinfo@indesit.net.au)

### NEW ZEALAND

EUROTECH DESIGN LIMITED

604 Rosebank Road, Avondale,

Auckland, New Zeland

Email: [parts@eurotechdesign.co.nz](mailto:parts@eurotechdesign.co.nz)

